



## Dual N-Channel 40-V (D-S) MOSFET

PRODUCT SUMMARY			
V <sub>DS</sub> (V)	r <sub>DS(on)</sub> (Ω)	I <sub>D</sub> (A) <sup>a</sup>	Q <sub>g</sub> (Typ)
40	0.060 at V <sub>GS</sub> = 10 V	5.0	5.6
	0.070 at V <sub>GS</sub> = 4.5 V	4.7	

### FEATURES

- TrenchFET® Power MOSFET
- 100 % R<sub>g</sub> Tested

### APPLICATIONS

- CCFL Inverter



RoHS  
COMPLIANT

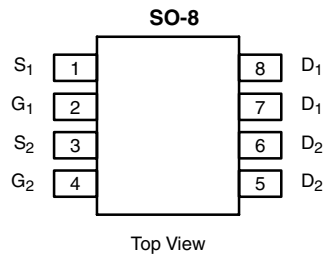

Ordering Information: Si4908DY-T1-E3 (Lead (Pb)-free)

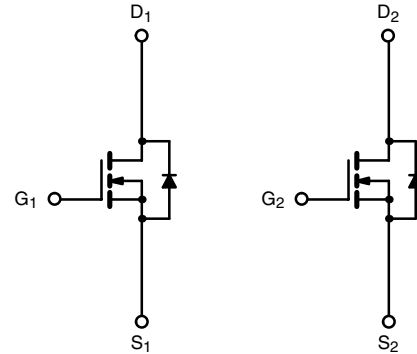

N-Channel MOSFET

N-Channel MOSFET

ABSOLUTE MAXIMUM RATINGS (T <sub>A</sub> = 25 °C UNLESS OTHERWISE NOTED)			
Parameter	Symbol	Limit	Unit
Drain-Source Voltage	V <sub>DS</sub>	40	V
Gate-Source Voltage	V <sub>GS</sub>	± 16	
Continuous Drain Current (T <sub>J</sub> = 150 °C)	I <sub>D</sub>	T <sub>C</sub> = 25 °C	A
		T <sub>C</sub> = 70 °C	
		T <sub>A</sub> = 25 °C	
		T <sub>A</sub> = 70 °C	
Pulsed Drain Current (10 μs Pulse Width)	I <sub>DM</sub>	20	A
Source-Drain Current Diode Current	I <sub>S</sub>	T <sub>C</sub> = 25 °C	
		T <sub>A</sub> = 25 °C	
Pulsed Source-Drain Current	I <sub>SM</sub>	20	
Single Pulse Avalanche Current	I <sub>AS</sub>	7	mJ
Single Pulse Avalanche Energy	E <sub>AS</sub>	2.5	
Maximum Power Dissipation	P <sub>D</sub>	T <sub>C</sub> = 25 °C	W
		T <sub>C</sub> = 70 °C	
		T <sub>A</sub> = 25 °C	
		T <sub>A</sub> = 70 °C	
Operating Junction and Storage Temperature Range	T <sub>J</sub> , T <sub>stg</sub>	-55 to 150	°C

THERMAL RESISTANCE RATINGS				
Parameter	Symbol	Typ	Max	Unit
Maximum Junction-to-Ambient <sup>b, d</sup>	R <sub>thJA</sub>	57	67.5	°C/W
Maximum Junction-to-Foot (Drain)	R <sub>thJF</sub>	35	45	

Notes

- Based on T<sub>C</sub> = 25 °C.
- Surface Mounted on 1" x 1" FR4 Board.
- t = 10 sec.
- Maximum under steady state conditions is 120 °C/W.

SPECIFICATIONS (T <sub>J</sub> = 25 °C UNLESS OTHERWISE NOTED)						
Parameter	Symbol	Test Condition	Min	Typ <sup>a</sup>	Max	Unit
<b>Static</b>						
Drain-Source Breakdown Voltage	V <sub>DS</sub>	V <sub>GS</sub> = 0 V, I <sub>D</sub> = 250 μA	40			V
V <sub>DS</sub> Temperature Coefficient	ΔV <sub>DS</sub> /T <sub>J</sub>	I <sub>D</sub> = 250 μA		40		
V <sub>GS(th)</sub> Temperature Coefficient	ΔV <sub>GS(th)</sub> /T <sub>J</sub>	I <sub>D</sub> = 250 μA		-4.6		
Gate Threshold Voltage	V <sub>GS(th)</sub>	V <sub>DS</sub> = V <sub>GS</sub> , I <sub>D</sub> = 250 μA	0.8		2.2	
Gate-Body Leakage	I <sub>GSS</sub>	V <sub>DS</sub> = 0 V, V <sub>GS</sub> = ± 16 V			100	nA
Zero Gate Voltage Drain Current	I <sub>DSS</sub>	V <sub>DS</sub> = 40 V, V <sub>GS</sub> = 0 V			1	μA
		V <sub>DS</sub> = 40 V, V <sub>GS</sub> = 0 V, T <sub>J</sub> = 55 °C			10	
On-State Drain Current <sup>b</sup>	I <sub>D(on)</sub>	V <sub>DS</sub> = 5 V, V <sub>GS</sub> = 10 V	20			A
Drain-Source On-State Resistance <sup>b</sup>	r <sub>DS(on)</sub>	V <sub>GS</sub> = 10 V, I <sub>D</sub> = 4.1 A		0.048	0.060	Ω
		V <sub>GS</sub> = 4.5 V, I <sub>D</sub> = 3.8 A		0.056	0.070	
Forward Transconductance <sup>b</sup>	g <sub>fs</sub>	V <sub>DS</sub> = 15 V, I <sub>D</sub> = 4.1 A		15		S
<b>Dynamic<sup>a</sup></b>						
Input Capacitance	C <sub>iss</sub>	N-Channel V <sub>DS</sub> = 20 V, V <sub>GS</sub> = 0 V, f = 1 MHz		355		pF
Output Capacitance	C <sub>oss</sub>			50		
Reverse Transfer Capacitance	C <sub>rss</sub>			29		
Total Gate Charge	Q <sub>g</sub>	V <sub>DS</sub> = 20 V, V <sub>GS</sub> = 10 V, I <sub>D</sub> = 5 A		8	12	nC
		N-Channel V <sub>DS</sub> = 20 V, V <sub>GS</sub> = 4.5 V, I <sub>D</sub> = 5 A		3.7	6	
Gate-Source Charge	Q <sub>gs</sub>			1.1		
Gate-Drain Charge	Q <sub>gd</sub>			1.4		
Gate Resistance	R <sub>g</sub>	f = 1 MHz		3.4	5.2	Ω
Turn-On Delay Time	t <sub>d(on)</sub>	N-Channel V <sub>DD</sub> = 20 V, R <sub>L</sub> = 4 Ω I <sub>D</sub> = 1 A, V <sub>GEN</sub> = 10 V, R <sub>g</sub> = 1 Ω		8	13	ns
Rise Time	t <sub>r</sub>			20	30	
Turn-Off Delay Time	t <sub>d(off)</sub>			23	35	
Fall Time	t <sub>f</sub>			27	42	
Turn-On Delay Time	t <sub>d(on)</sub>	N-Channel V <sub>DD</sub> = 20 V, R <sub>L</sub> = 4 Ω I <sub>D</sub> = 1 A, V <sub>GEN</sub> = 4.5 V, R <sub>g</sub> = 1 Ω		74	110	
Rise Time	t <sub>r</sub>			95	145	
Turn-Off Delay Time	t <sub>d(off)</sub>			31	48	
Fall Time	t <sub>f</sub>			33	50	
<b>Drain-Source Body Diode Characteristics</b>						
Continuous Source-Drain Diode Current	I <sub>S</sub>	T <sub>C</sub> = 25 °C			2.3	A
Pulse Diode Forward Current <sup>a</sup>	I <sub>SM</sub>				20	
Body Diode Voltage	V <sub>SD</sub>	I <sub>S</sub> = 1.5 A		0.8	1.2	V
Body Diode Reverse Recovery Time	t <sub>rr</sub>	N-Channel I <sub>F</sub> = 2 A, di/dt = 100 A/μs, T <sub>J</sub> = 25 °C		26	40	ns
Body Diode Reverse Recovery Charge	Q <sub>rr</sub>			26	40	nC
Reverse Recovery Fall Time	t <sub>a</sub>			13		ns
Reverse Recovery Rise Time	t <sub>b</sub>			13		

## Notes

- a. Guaranteed by design, not subject to production testing.  
b. Pulse test; pulse width ≤ 300 μs, duty cycle ≤ 2 %.

Stresses beyond those listed under "Absolute Maximum Ratings" may cause permanent damage to the device. These are stress ratings only, and functional operation of the device at these or any other conditions beyond those indicated in the operational sections of the specifications is not implied. Exposure to absolute maximum rating conditions for extended periods may affect device reliability.



**TYPICAL CHARACTERISTICS (25 °C UNLESS NOTED)**

**Output Characteristics**

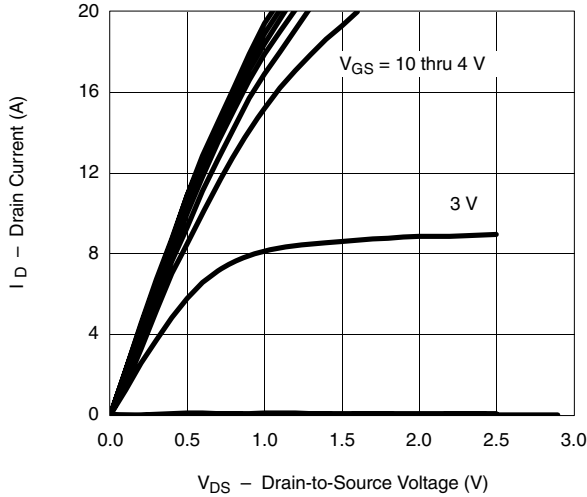

**Transfer Characteristics**

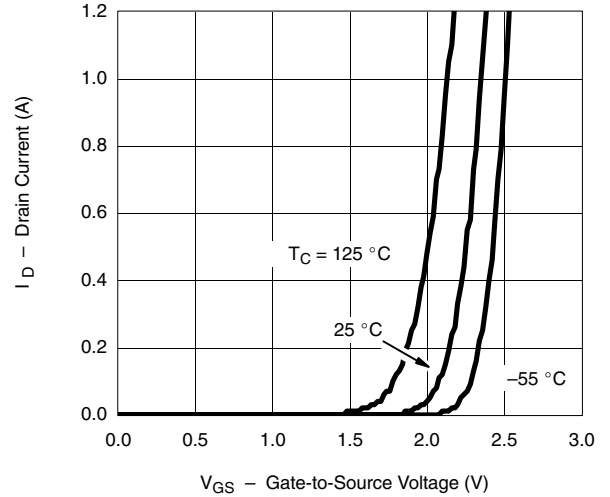

**On-Resistance vs. Drain Current and Gate Voltage**

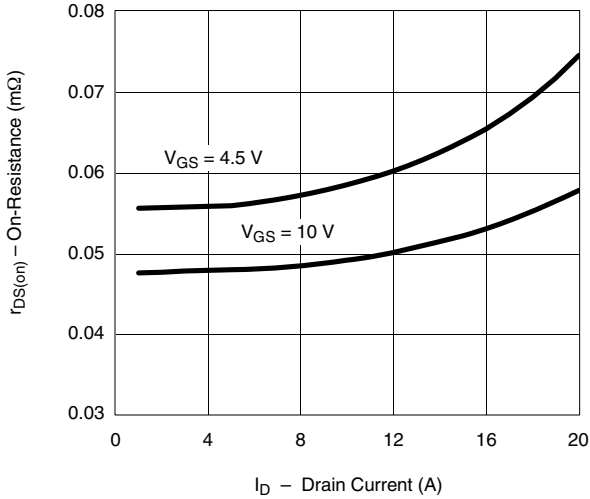

**Capacitance**

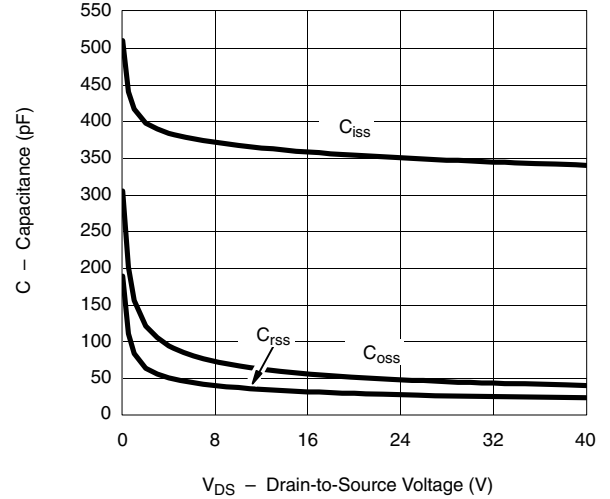

**Gate Charge**

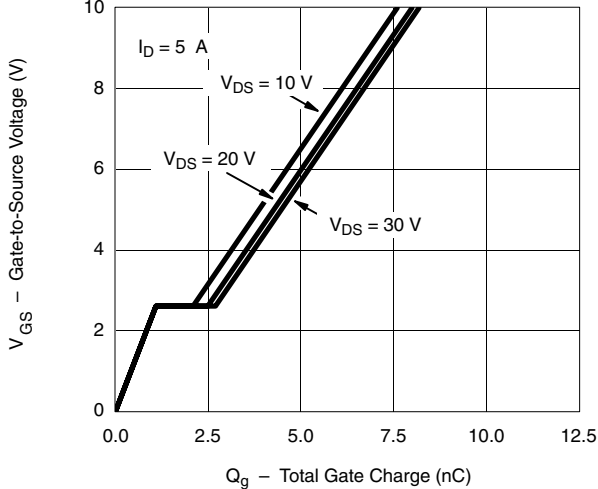

**On-Resistance vs. Junction Temperature**

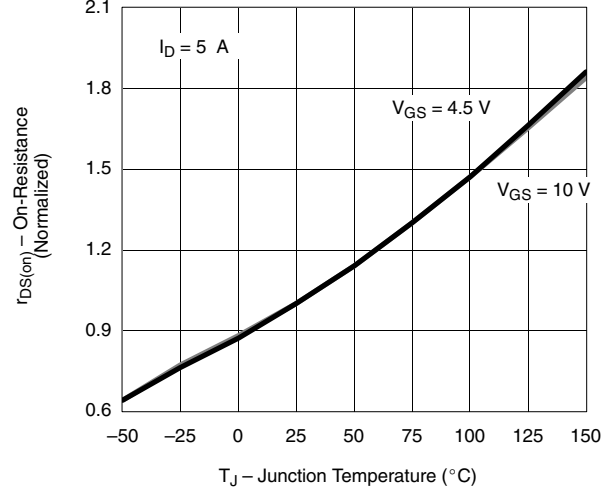



**TYPICAL CHARACTERISTICS (25 °C UNLESS NOTED)**

Source-Drain Diode Forward Voltage

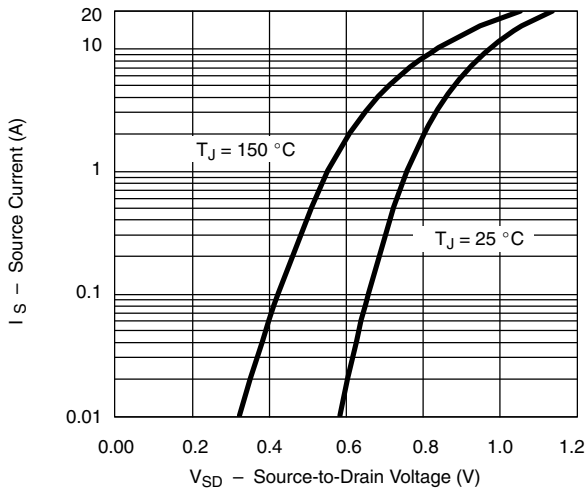

On-Resistance vs. Gate-to-Source Voltage

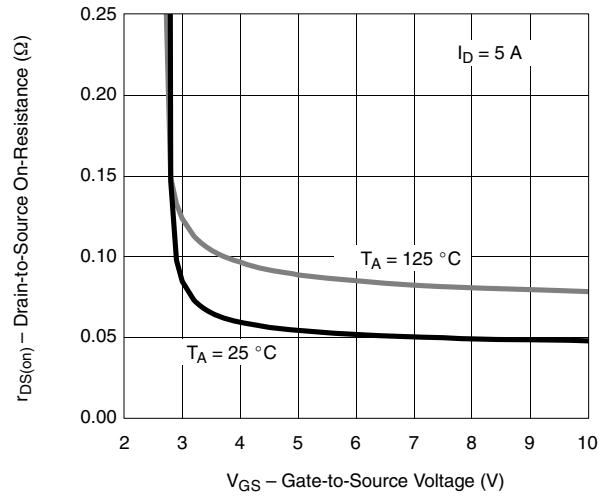

Threshold Voltage

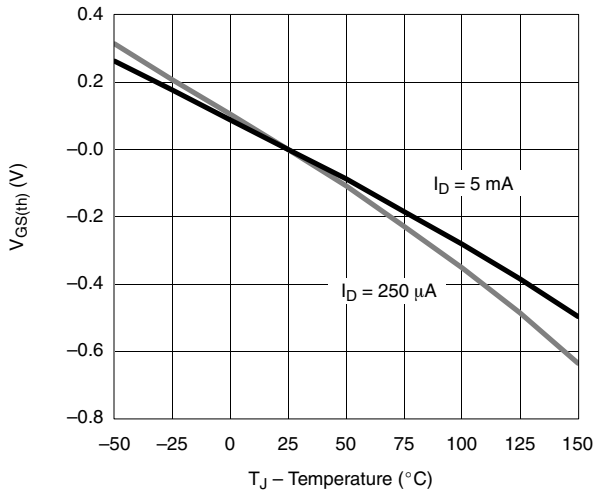

Single Pulse Power, Junction-to-Ambient

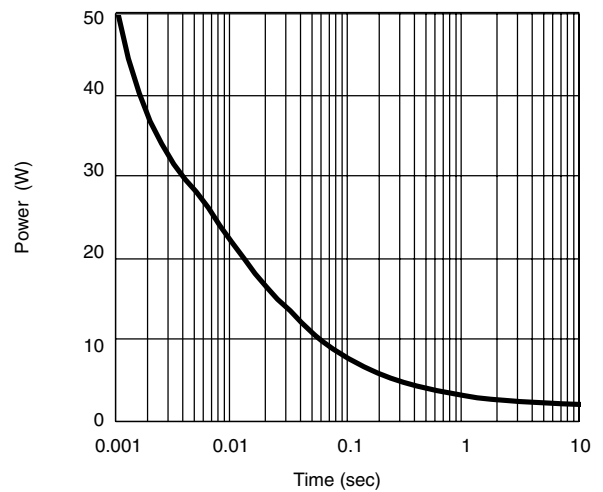

Safe Operating Area, Junction-to-Ambient

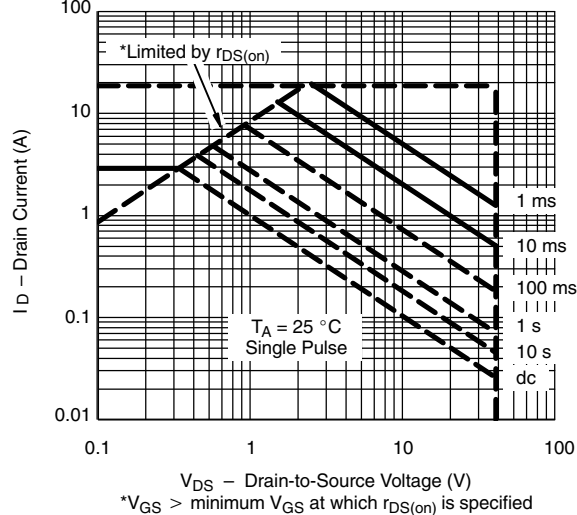



**TYPICAL CHARACTERISTICS (25 °C UNLESS NOTED)**

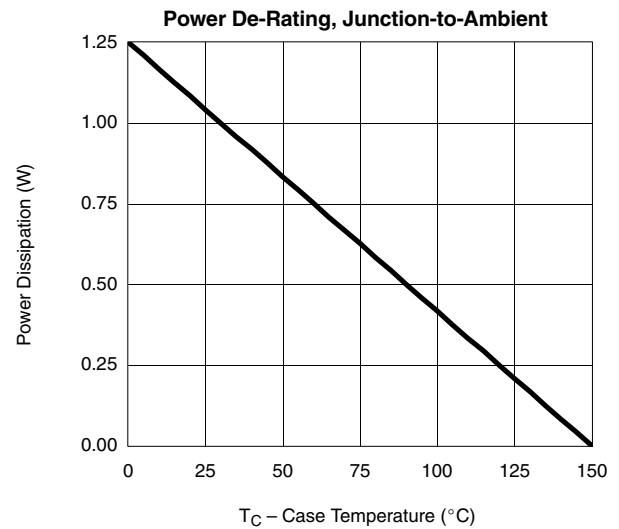
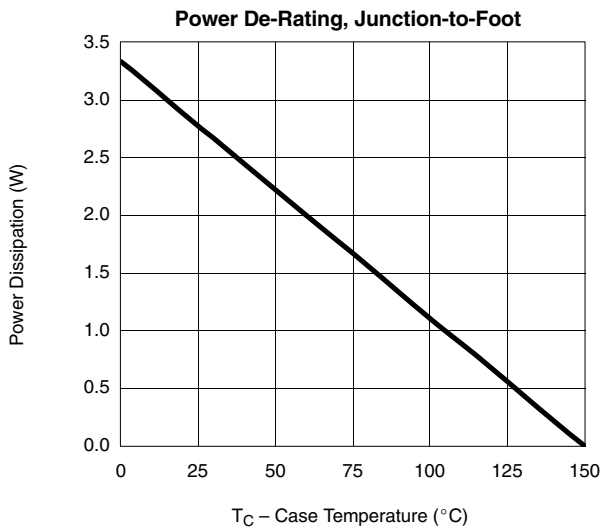
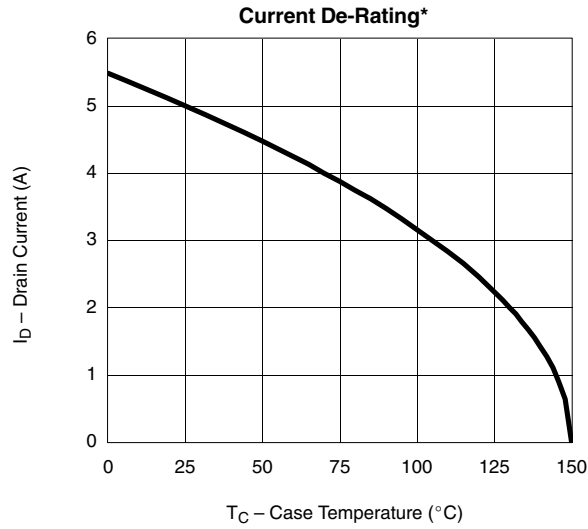

\*The power dissipation  $P_b$  is based on  $T_{J(max)} = 150\text{ °C}$ , using junction-to-case thermal resistance, and is more useful in settling the upper dissipation limit for cases where additional heatsinking is used. It is used to determine the current rating, when this rating falls below the package limit.



**TYPICAL CHARACTERISTICS (25 °C UNLESS NOTED)**

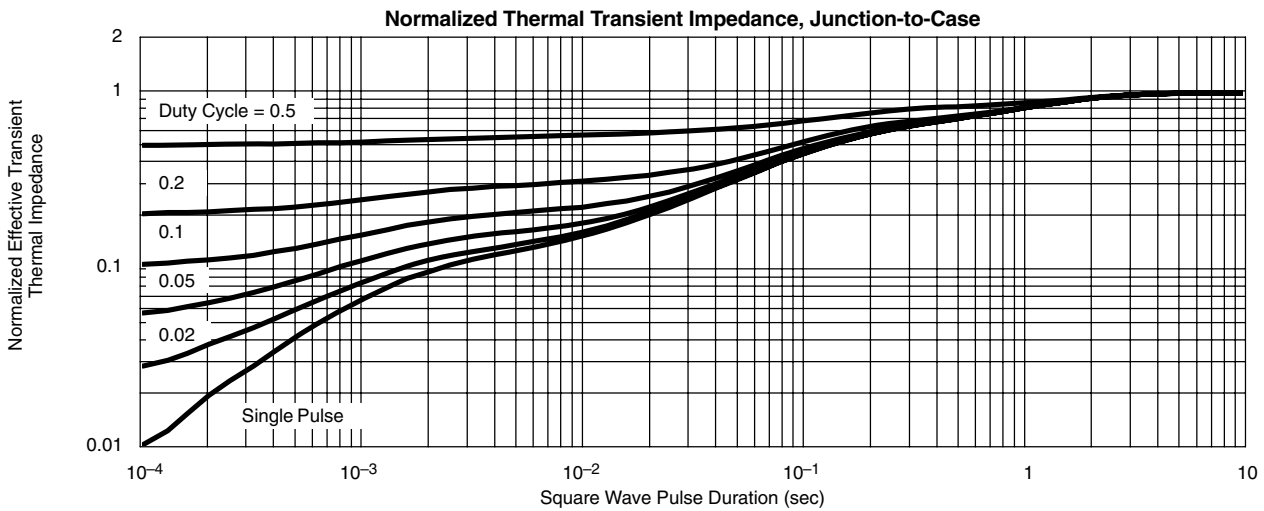
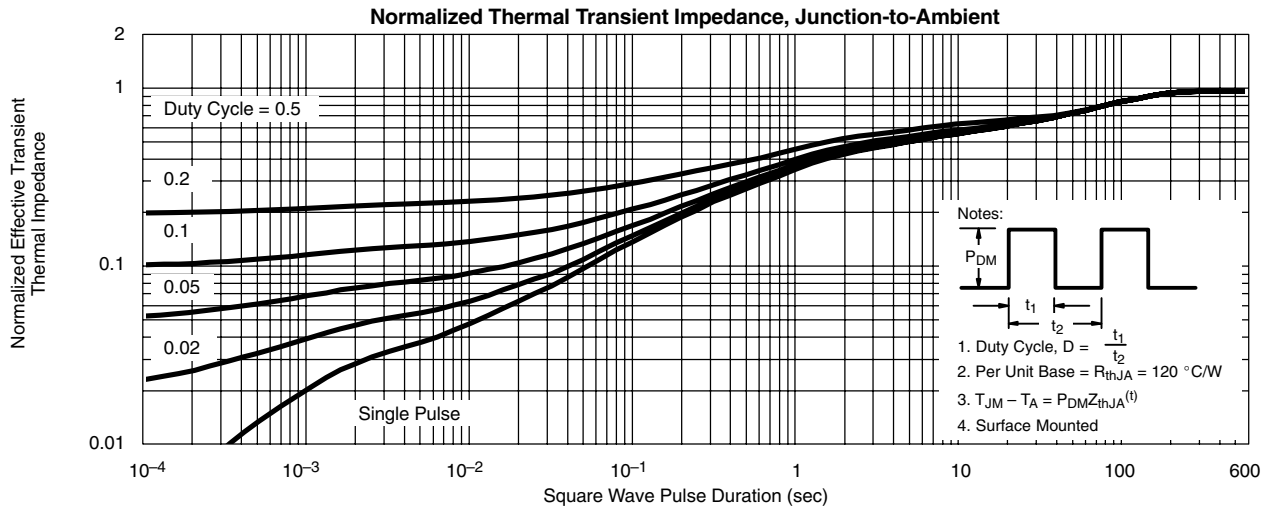

Vishay Siliconix maintains worldwide manufacturing capability. Products may be manufactured at one of several qualified locations. Reliability data for Silicon Technology and Package Reliability represent a composite of all qualified locations. For related documents such as package/tape drawings, part marking, and reliability data, see <http://www.vishay.com/ppg?73698>.



## Disclaimer

All product specifications and data are subject to change without notice.

Vishay Intertechnology, Inc., its affiliates, agents, and employees, and all persons acting on its or their behalf (collectively, "Vishay"), disclaim any and all liability for any errors, inaccuracies or incompleteness contained herein or in any other disclosure relating to any product.

Vishay disclaims any and all liability arising out of the use or application of any product described herein or of any information provided herein to the maximum extent permitted by law. The product specifications do not expand or otherwise modify Vishay's terms and conditions of purchase, including but not limited to the warranty expressed therein, which apply to these products.

No license, express or implied, by estoppel or otherwise, to any intellectual property rights is granted by this document or by any conduct of Vishay.

The products shown herein are not designed for use in medical, life-saving, or life-sustaining applications unless otherwise expressly indicated. Customers using or selling Vishay products not expressly indicated for use in such applications do so entirely at their own risk and agree to fully indemnify Vishay for any damages arising or resulting from such use or sale. Please contact authorized Vishay personnel to obtain written terms and conditions regarding products designed for such applications.

Product names and markings noted herein may be trademarks of their respective owners.